

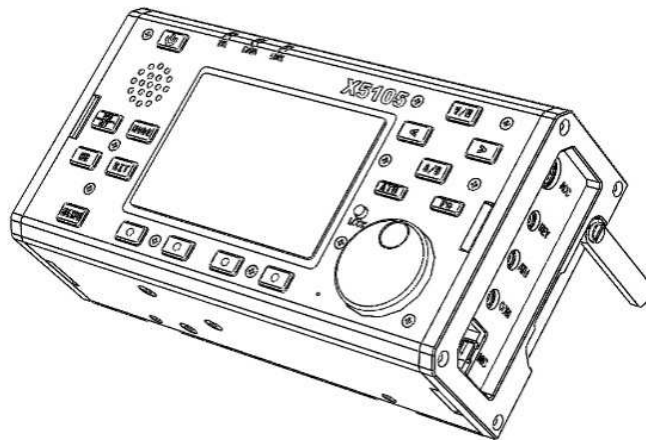

## Xiegu Communication X5105

### HF+50MHz Portable HF Transceiver©

Distributed Exclusively in the USA by MFJ Enterprises



#### Features:

- High-Visibility 3.6- Inch LCD Screen
- Built-in 3800-mAh high-capacity battery
- Built-in SWR Bridge and ATU
- All modes (USB/LSB/CW/AM/FM/Digital)
- All Bands (160-M through 6-M)
- General Coverage Receiver
- 1<sup>st</sup>-IF Signal Output for Spectrum Display
- DSP-NR, Noise Blanker, Notch Filter
- Memory Keyer with CW trainer
- Speech-Processing Compressor
- Firmware Download Upgradable
- Multi-function Keypad Microphone
- Built-in Desktop Stand

**Packing List** - Confirm that your transceiver package includes the following items:

- X5105 Transceiver
- Multi-Function Keypad Microphone and cord
- Power Supply Cable
- USB Data Cable
- 3.5mm Plug
- Warranty Card and Certificate
- Instruction Manual

**Introduction:** The USA version of Xiegu's X5105 Transceiver is distributed and backed exclusively by MFJ Enterprises. This unique radio delivers an exceptionally wide range of operating features normally found only in more-costly base-station radios. For example, the general-coverage receiver tunes continuously from the AM broadcast band to 54 MHz. VFO tuning is velvet-smooth with a wide range of tuning rates – including 1-Hz steps for critical data reception. DX splits are easy using the VFO A/B function, and a wide-range RIT with digital readout lets you scout adjacent frequencies in both directions. The X5105 transmits on 160 through 6 Meters (amateur bands only) with power output adjustable from 0.5 to 5.0 Watts. Operating modes include USB/LSB, CW, FM, AM, plus digital transmissions (1.5-W carrier on AM). There's also a built-in SWR Bridge and Automatic Antenna Tuner (ATU) that will put you on the map from virtually any portable location using improvised antenna systems.

When it comes to pulling weak DX signals out of the noise, the X5105's "big-radio" features make all the difference! There's a built-in Pre-Amp and Attenuator, pulse-type Noise Blanker, Digital Noise Reduction (DNR), Notch Filter, adjustable AGC-Rate (fast, slow, automatic, off), plus variable high and low pass audio filters, built in speaker, and plenty of audio power to drive an external speaker. Serious CW operators will appreciate the built-in multi-mode Automatic Keyer with three memory channels and CW-trainer. There's also built-in Speech Processing for added DX punch. The electret hand microphone features a multi-function key-pad that places many of the radio's advanced operating features right at your fingertips. Whether operating indoors or out, the X5105's large 3.6-inch high-visibility back-lit screen displays every aspect of your radio's operation with easy-to-read numerals, letters, and analog scales. And, even though the X5105 is physically small, all operating controls are clearly marked and spaced apart to accommodate adult-sized fingers!

Thanks to all these features, you can say goodbye to the tangled patch cables and add-on boxes that normally accompanies QRP operation. There's even a front-panel microphone and manual transmit switch for operating "handy-talkie" mode. Best of all, the powerful 3800-mAh on-board battery pack delivers 6 to 8 hours of energy-independent portable operation between charges. The radio operates from any external 9-15 Volt 3-Amp dc supply, and a built-in smart-charger monitors battery condition. Even though it's loaded with special features, the X5105 measures just 6-5/8" wide x 3-5/8" high x 1-7/8" deep and weighs just 2.1 pounds with the battery included. Positive proof that remarkable things come in small packages!

## SPECIFICATIONS

**Receive Range:** Continuous, 500kHz to 54MHz

**Transmit Range:** 160-M through 6-M (Amateur bands only)

**Operating Mode:** A1A(CW), A3E(AM), J3E(USB/LSB), F3E(FM)

**Temperature Range:** -10°C ~ +60°C

**Stability:** First Hour, + 4ppm @25°C. After First Hour, 1ppm

**Voltage:** 13.8VDC ± 15%, (9–15 Vdc)

**Current:** Rx, 500 mA Peak, Tx, 2.5 A Peak

**Battery:** 3800 mAh @ 12Vdc

**Dimensions:** 6-5/8" W, 3-5/8" H, 1-7/8" D

**Weight:** 2.1 lbs.

**Transmit Power Output:** 0.5 – 5.0 W PEP SSB/CW/FM (0.5-W increments)

**AM:** Low-level, Reverse-Amplitude Modulation (5-W Carrier, 1.5-W on voice peaks)

**FM:** Reactance Modulation, ±5kHz

**Harmonics, Spurs:** > -45dBc

**AF Input:** 200-10k (600-Ω microphone)

**Receiver:** Superhet, 1st IF: 70.455MHz, 2nd IF: 10.695MHz, 3rd IF: 455kHz (NFM only)

### Rx Sensitivity:

	SSB/CW	AM	FM
1MHz-1.8MHz	0.35uV	10uV	/
1.8MHz-28MHz	0.25uV	2uV	/
28MHz-30MHz	0.25uV	2uV	0.35uV
50MHz-54MHz	0.25uV	2uV	0.35uV

(PRE=on, ATT=off, NB=off, NR=off, SSB/CW/AM = 10dB S/N, FM = 12dB SINAD)

**Image Rejection:** -70dB

**IF Rejection:** 60dB

**Selectivity: SSB:** -6dB @ 2.4 kHz, -60dB @ 4.6 kHz

**CW:** -6dB @ 500 Hz, -60dB @ 2 kHz

**AM:** -6dB @ 6 kHz, -60dB @ 25 kHz

**FM:** -6dB @ 12 kHz, -60dB @ 25 kHz

**DSP Noise Reduction:** AF DSP, variable

**AF Output:** 0.6W into 8Ω, ≤10% THD

**Firmware Version:** V1\_0\_04 Build 014 March 21 2018

**EXTERNAL CONNECTIONS**

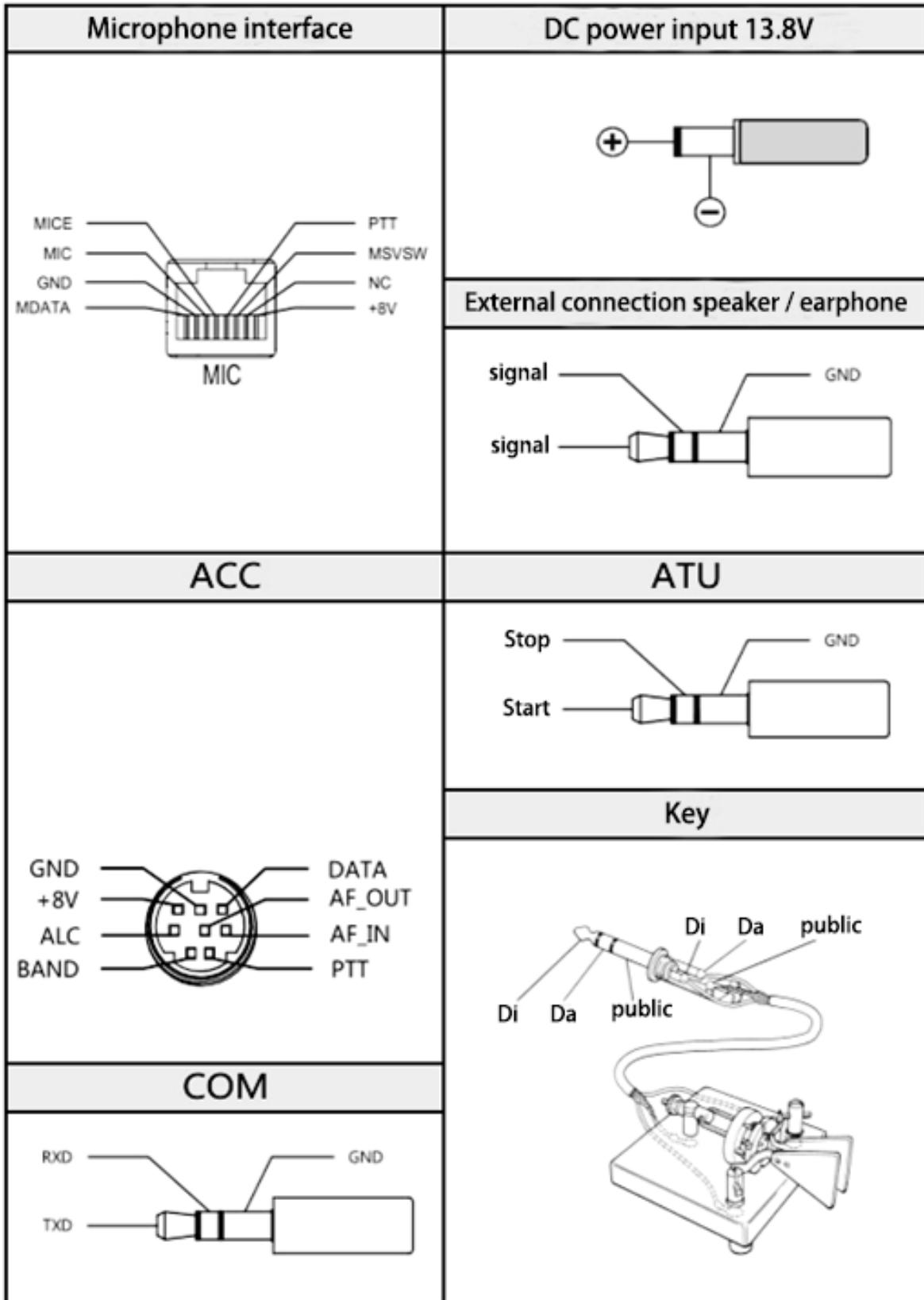

**INTERNAL BATTERY**

The X5105 comes with a built-in 3800-mAh battery pack. When no external power source is connected to the power jack, the battery supplies power to the radio. When a power source is connected, the radio senses the external voltage and switches over to it.

**Charging Procedure:** You may listen to the X5105 while it is charge mode -- but avoid transmitting while charging is taking place. The combined current required to simultaneously transmit and charge the Lithium ion cells could exceed the capacity of the radio's power-management components. To initiate a charge cycle while the radio is operating:

Scroll to Menu-7, select [CHG] (charge), then select CHG ON (charger on).

To ensure a full charge, apply at least 13.5 volts from the external power source (normal charge range is 13.5–14.0 volts). Charging begins automatically and is monitored by the charge controller.

The maximum charge time required for a fully depleted battery is 12 to 15 hours. When the battery is fully charged, the charge controller automatically terminates the charge cycle.

When your radio is turned off with external power connected, the battery automatically recharges, as needed, to restore a full charge.

When battery power is nearly depleted, the battery symbol located at the upper right corner of the display screen will appear to be "empty" . At this point, you should switch to an external supply or recharge the battery right away. Note that during the recharge cycle, it is normal for the X5105 heatsink and case to become slightly warm. Normal life span for the internal battery is about three years. Contact MFJ Enterprises to order a replacement when you observe a significant drop in capacity or if the battery fails to hold a charge. Note that routine battery replacement is not covered under warranty.

**IMPORTANT OPERATING WARNING: DO NOT** abruptly disconnect the power supply when the X5105 is connected to an external power source and the radio is transmitting. Doing so can damage the radio's power-management components. Also, avoid transmitting while simultaneously charging the battery.

**IMPORTANT BATTERY WARNING:** Lithium-ion batteries are widely used in electronic devices and the technology is safe. However, in rare isolated cases, Lithium ion batteries have been known to fail internally and overheat. Should such a failure occur involving the battery in your X5105, the radio's enclosure would likely become extremely hot to the touch. In this event, disconnect the radio's external power source and immediately remove the radio to a well-ventilated flame-resistant area. After the case cools down, contact MFJ with a detailed description of the event and request specific handling instructions.

## CONTROLS AND FUNCTONS

### Front panel:

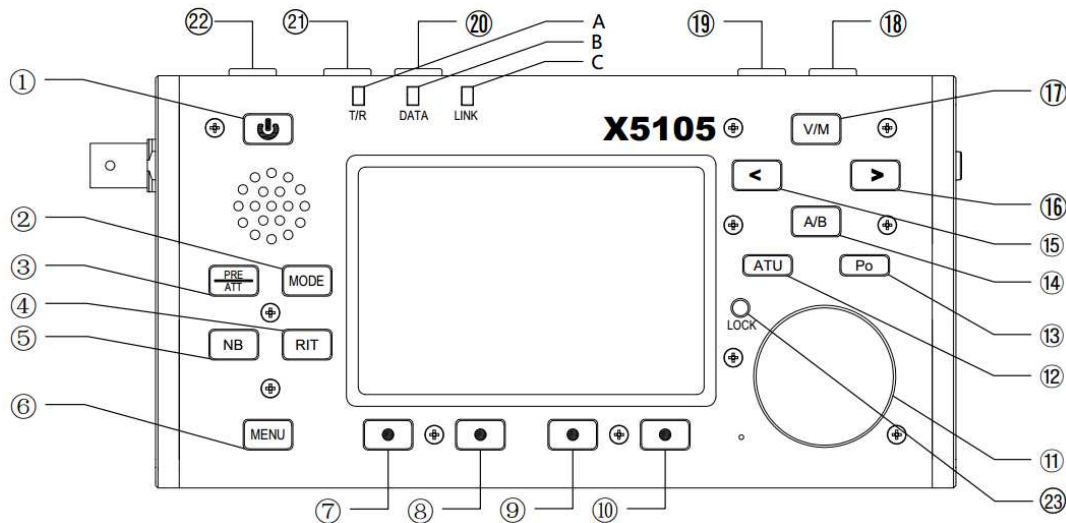

#### 1. Power Button:

Press and hold for 1 second to turn the radio on or off.

#### 2. Mode Button:

Step or scroll to change the radio's operating mode: [LSB-USB-CW-CWR-NFM-AM]

#### 3. PRE/ATT Button:

Step or scroll to select receiver sensitivity Range: [PRE=ON, ATT=ON, PRE/ATT=OFF]

#### 4. RIT Button:

Press to toggle the RIT (receiver incremental tuning) function on or off.

#### 5. NB Button:

Press to toggle the NB (noise blanker) function on or off.

#### 6. MENU Button:

Press Menu to display menu selections and to step through available functions.

#### 7. – 10. Multifunction-Menu Buttons:

Press to access a desired function (functions appear above each button on the screen).

#### 11. Main Tuning Knob:

Tunes the X5105 VFO, also adjusts some menu parameters.

#### 12. ATU Button:

Press momentarily to bring the ATU (automatic antenna tuner) on line.

Press and hold to activate the ATU's automatic tuning cycle.

#### 13. Po Button:

Press and rotate the VFO knob to set RF-Power Output level (0.5W-5W).

#### 14. A/B Button:

Press to toggle between VFO-A and VFO-B.

**15. (<) Button:**

Press to shift VFO frequency step one decimal place to the left.

**16. (>)Button:**

Press to shift VFO frequency step one decimal place to the right.

**17. V/M Button:**

Press to toggle between VFO mode and MEMORY mode.

**18. “UP” Button:**

Step or toggle to select a higher-frequency band.

**19. “DN” Button:**

Step or toggle to select a lower-frequency band.

**20. (–) Speaker Button:**

Step or toggle to lower the volume setting.

**21. (+) Speaker Button:**

Step or toggle to select a higher volume setting.

**22. PTT Button:**

Press and hold to actuate transmit mode (MOX function).

**23. LOCK Button:**

Press to lock all control settings. Press and hold to release control lock.

Press and hold for several seconds to toggle the display backlight on or off.

**Colored Status LEDs:** (located above display screen)

**A - T/R:** Green LED = Receive Mode, RED LED = Transmit Mode

**B – DATA:** Flashes when data signals are present or a monitored channel is busy.

**C – LINK:** Illuminates when radio is connected to peripheral equipment.

**FUNCTION MENU:** The function menu has nine pages (**M1-M9**) with three or four soft-menu entries per page. Refer to the expanded **Function Menu** section of the manual for detailed operating instructions:

**M1 - A=B:** Copy VFO A to B, **SPL:** VFO split-frequency, **NR:** Noise reduction level, **NTH:** Notch filter freq.

**M2 - AGC:** AGC time constant, **FIL:** Select IF filter, **SRM:** Scan in receive mode, **SWR:** Scan SWR (Tx)

**M3 - M>V:** Memory>VFO, **MW:** VFO>Memory, **MC:** Clear Memory, **TAG:** Add text label to memory

**M4 - BK:** CW Break-in, **KEY:** Manual or Auto, **KSP:** Set keyer speed in WPM

**M5 - RE1:** CW Mem-1, **RE2:** CW Mem-2, **RE3:** CW Mem-3, **CSN:** Add call to boot screen

**M6 - SQL:** Squelch, **CMP:** Transmit Processor, **MTR:** Select bar-graph Display, **VLT:** Volts or Battery%

**M7 - CHG:** Charger switch, **MSL:** Mic Select - (int/ext), **IFO:** IF output switch, **VER:** Firmware version

**M8 - MDN:** Digital modem, **CAR:** Carrier tracking, **AFC:** Frequency tracking

**M9 – AFF:** Digital AF filter, **HPF:** High-pass set, **LPF:** Low-pass set, **SPK:** Speaker/Phones audio level

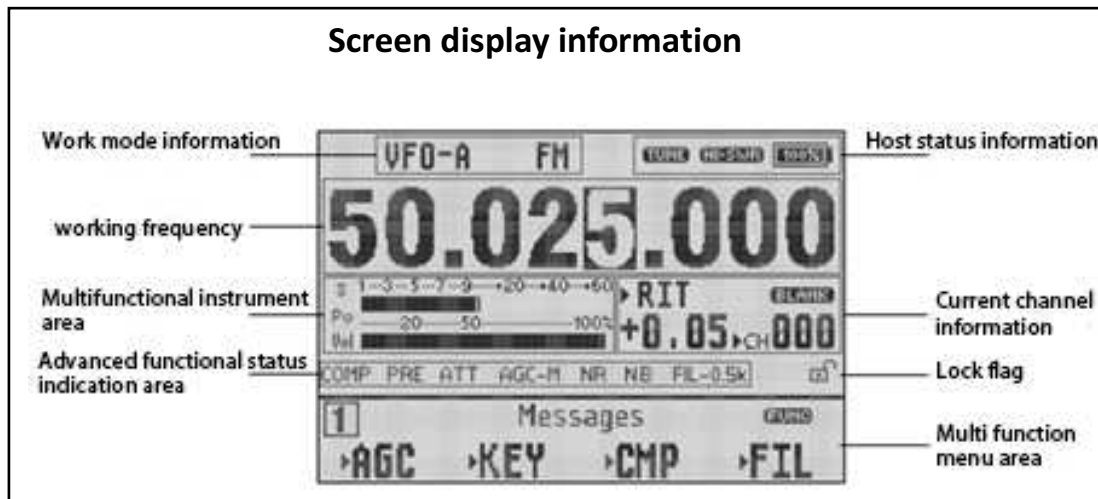

## LEFT-SIDE PANEL CONNECTIONS

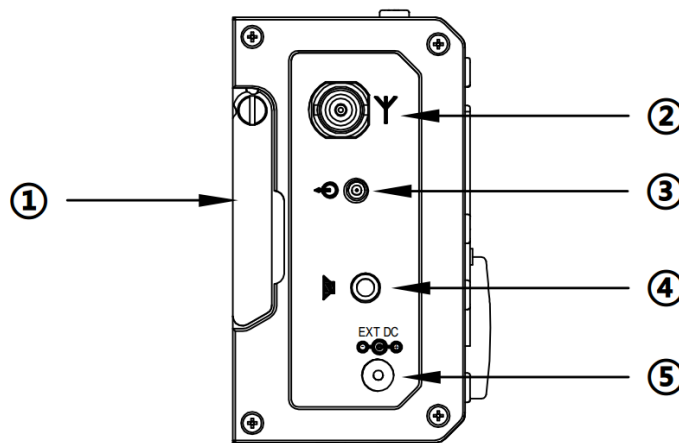

- 1. Desk Stand Bracket:** Swings down to prop radio upright on a table or desktop.
- 2. Antenna Connector:** Accepts 50 Ω BNC-Male connector from antenna system
- 3. IF-Signal Output:** Connects 1st-IF output to Xiegu XDT1 data terminal.
- 4. External Speaker/Phones:** Accepts 3.5mm stereo plug (3 wire) for speaker or phones.
- 5. DC Power Connector:** Accepts a standard 2.1 mm x 5.5 mm coaxial power plug, (+) center. Supply must deliver at least 13.8-V @ 3-A to fully charge the battery.



**RIGHT-SIDE PANEL CONNECTIONS:**

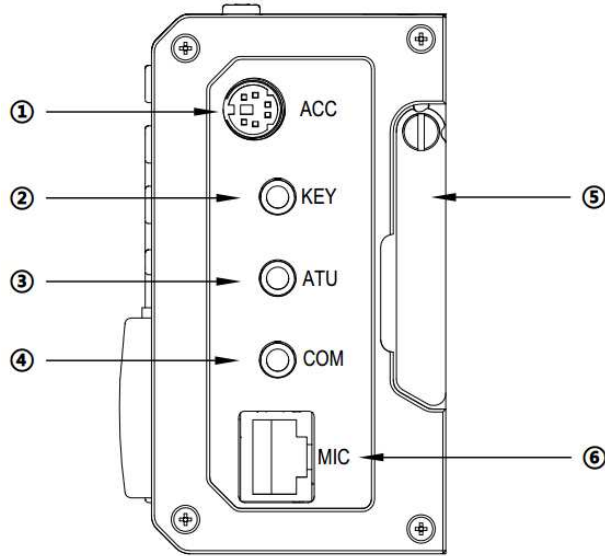

1. **ACC (Accessory) Jack:** Accepts male 8-PIN micro-DIN. Interface to external PA or data controller.
2. **KEY Jack:** Accepts 3.5mm stereo male plug connected to manual or automatic key.
3. **ATU Jack:** Accepts 3.5mm stereo male plug to provide control levels for external band switch.
4. **CIV Interface:** Accepts 3.5mm male stereo plug for serial-port interface (firmware updates, etc.)
5. **Right bracket:** Swings down to prop up radio on table or desk top.
6. **MIC (microphone) Jack:** Accepts X5105 microphone connector.

**NOTE** For best results on the 3.5mm Jacks use the included 3.5mm Stereo Plug to insure the plug can fully plug in.

**HANDHELD MICROPHONE:**



1. **Lock Button:** Toggle to lock or unlock radio's controls
2. **PTT Button:** Push to Transmit
3. **Up/Down:** Steps VFO frequency higher or lower.
4. **Rx/Tx LED:** Displays Receive/Transmit status.

5. **Digital keypad:** 1-10 Tone Encoder.
6. **FIL Button:** Toggle to change filter passband.
7. **MODE Button:** Toggle to change operating mode.
8. **Mic Element:** Opening for electret microphone element
9. **F1/F2:** Custom settings buttons.
10. **MW:** Memory Write button (store frequency).
11. **V/M:** Switch between VFO and stored frequency.
12. **XFC Button:** No function
13. **CALL Button:** Press and hold for Automatic Antenna Tuning (ATU)

## **BASIC OPERATION**

The X5105 is firmware-driven, so familiarity with the operation of the various controls and with the menu system is important. To make best use of these instructions, have your radio in hand and walk through each function as you read along.

[ ] **Power ON:** Press and hold **BOOT** (power) button for 1-2 seconds. The radio will beep three ascending tones\* and the Xiegu logo will appear on screen. Then, in 2-3 seconds, the screen will change to the regular operating display (freq., mode, etc.). Note that the radio's **CSN** menu will allow you to personalize your radio by adding your call and/or name to the power-on boot screen.

[ ] **Power OFF:** Press and hold **BOOT** (power) button for 2-3 seconds. The radio will beep three descending tones and "BYE" will appear on the screen. In 2-3 seconds the screen will go dark, indicating the radio is fully turned off.

[ ] **Forced Reset:** In the unlikely event the processor "locks up" or fails to respond to your commands, press and hold **Boot** for 10 seconds. This will force a reset of the MCU and shut the radio down.

[ ] **Band:** Step through all US amateur bands by pressing the **DN** (down) or **UP** button located on top of the radio on the righthand side. The menu is circular: **160M> 80M> 60M> 40M> 30M> 20M> 17M> 15M> 12M> 10M> 6M.**

[ ] **Mode:** Step through choices using the **MODE** button to the left of the display screen. This menu is circular: **LSB> USB> CW> CWR(rev)> NBFM> AM.** The X5105 offers a range of special features and functions for each mode, all covered in detail in the expanded **Function Menu** section of the manual.

[ ] **Volume:** Change the sound level with buttons marked with a large and small speaker symbol located on top of the radio, left side. A **VOL** bar-graph located below the S-meter scale displays the current AF level from 0% to 100%. Note that the audio signal level routed to the **AF-OUT** line on the **ACC** (accessory) jack is independent of the volume buttons. That level is set in the system menu.

[ ] **Transmit Output Power:** Press the **Po** button located above the VFO tuning knob. **>TX POWER** will appear on the right side of the display with the output level displayed underneath it (example: **5.0W**). To reset, rotate the **VFO** encoder knob. Output level will change in 0.5-watt increments from 5.0-W to 0.5-W. Five seconds following the adjustment, normal **VFO** tuning will be restored to the encoder.

**Important Operating Note:** Before transmitting into an antenna with unknown SWR, always reduce power to the lowest level and engage the ATU (automatic antenna tuner).

[ ] **VFO Operation:** There are two ways to tune the X5105 VFO:

1. Use the **VFO Knob** and **Step Keys**: The current tuning step is highlighted on the frequency display, and the **Step Keys** (< >) shifts the highlight left or right. Tuning steps are: **1 Hz > 10 Hz > 100 Hz > 1 kHz > 10 kHz > 100 kHz > 1 MHz > 10 MHz**. Use larger steps for out-of-band general coverage tuning or to change band segments. Use smaller steps to tune in discrete signals. The **VFO** knob's encoder changes frequency by 12 increments with each revolution.
2. You may also use the up (^) or down (v) keypad buttons on the microphone to shift the VFO by one increment per click. These buttons are located immediately above the Rx/Tx LED.

[ ] **ATU (Automatic Antenna Tuner):** Press the **ATU** button once to engage the internal tuner -- the **TUNE** icon will appear at the top of the screen. Then, *press and hold* the **ATU** button while watching the S-meter display. When the bar-graph returns to 0 or stops moving, the tuning cycle is complete and the radio automatically switches back to receive mode. To disengage the tuner, press **ATU** once and the **TUNE** icon will disappear.

**IMPORTANT WARNING:** *Always connect a load to the Antenna connector when testing the ATU or when transmitting.*

[ ] **RIT (Receiver Incremental Tuning):** This function changes the receiver frequency without changing the transmit frequency. To enter the function, press **RIT**. The **RIT** icon will appear on the right side of the screen, and the RIT offset in  $\pm$  kHz will appear directly below it. Rotate the **VFO** knob to program set the desired amount of offset. After 5 seconds, normal VFO operation is restored.

[ ] **PRE/ATT (Preamp/Attenuator):** Press to step through three choices: **ATT** (attenuator) > **OFF** (bypass) > **PRE** (preamplifier). Note that the preamp is unnecessary on the lower HF-bands and may even cause front-end overload when many strong signals are present.

[ ] **Nose Blanker (NB):** Press **NB** to toggle the noise banker on and off. **NB** is highly effective for suppressing impulse noise generated by ignition systems, electric fences, etc. When on, the **NB** logo appears next to the **FIL** (IF bandwidth) indicator. Turn this function off when not needed -- impulse blanker may make strong adjacent-channel signals appear to splatter or distort. Note that DNR (digital noise reduction) is more effective for reducing generalized atmospheric static and random electrical noise.

[ ] **Data MODEM:** The X5105 has a built-in receive modem for copying PSK31 (see **Function Menu** section).

[ ] **VFO-A/B:** The X5105 features two independent VFOs. These may be set up for two in-band frequencies, for frequencies on two different bands, and even for split operation using two different modes. Press the **A/B** button (above tuning knob) to toggle between **VFO-A** and **VFO-B**. The VFO in use will be displayed at the top-left of the screen as **VFO-A** or **VFO-B**.

To operate "split" in DX pileups, set *receive frequency* with **VFO-A** and *transmit frequency* with **VFO-B**. Then, turn on the **SPL** (split) function on menu page-1 (**M1** -> **SPL**). The radio will now switch automatically from **VFO-A** to **VFO-B** when you transmit. Whenever split is on, the **SPLT** icon will appear on the screen next to the AGC icon.

[ ] **LOCK Button:** The lock feature freezes all controls, protecting them from accidental change. Press **LOCK** (small red button to the right of the display) to engage the function. A small **Padlock** icon will appear to the left of the button on the display. Press **LOCK** again to disengage the lock.

[ ] **Display Backlight:** Press and hold the **LOCK** button for approximately 3 seconds to toggle the display backlight on or off.

**FUNCTION MENU:** Many of the X5105's advanced features are accessed via the Function Menu. Use this section of the manual to "walk through" and become familiar with each one.

**FUNCTION MENU PAGES:** The Function Menu has nine pages (**M1-M9**), with three or four entries per page. The current page number is displayed in a box at the lower-left corner of the display screen. To change the page, press **MENU** and the page number will blink. Rotate the **VFO** encoder to select a new page number, then press **MENU** again to lock it in. The menu is circular, stepping **M1** to **M9**.

**SOFT KEYS:** The four buttons at the bottom of the display screen are called **Soft Keys**. Each one will be labeled with a two or three letter designator appearing above it on the screen. Labels for the soft keys change with each new page.

### Menu Page-1 [M1]

[ ] **A=B:** Press to copy all parameters stored in **VFO-A** over to **VFO-B**. Parameters may include band, frequency, operating mode, etc. After entry, the **VFO-A** or **VFO-B** settings may be modified, as needed.

[ ] **SPL** (Split): Press **SPL** to initiate automatic split-frequency operation. In this mode, you may tune around using **VFO-A**, but when you transmit, the radio automatically switches to the settings you've retained in **VFO-B** (an important DX operating aid).

[ ] **NR** (Digital Noise Reduction): This function activates and sets the radio's digital noise-reduction level. Press **NR** and the current **NR-Level** will appear on the display with a number from **0** and **10**. Use the **VFO** encoder knob to alter the noise reduction level. When set for **0**, the **NR** circuit is **off**. When set between **1-10**, it is **on**. The **NR** status indicator appears on-screen to the right of the AGC icon.

To adjust, listen to incoming signals and rotate the **VFO** encoder for the most comfortable processing level. Five seconds after your last entry, the encoder will revert back to normal VFO operation. Digital Noise Reduction works well for general QRN, static crashes, splatter, powerline noise, etc. Setting **1** delivers minimum processing, and **10** the maximum. *Set to 0 to turn the function off.* Note that **NB** impulse blanking may work better for pulsed noises such as auto ignitions and electric fences.

[ ] **NTH** (Notch Filter): Used to reduce or eliminate unwanted carriers and noise bands. Press **NTH** to engage. *When set to 0, the filter is off and out of the circuit.* When set from **1-100**, it is on. Adjust the **VFO** encoder to position the notch for minimum interference. Once set, normal VFO operation will be restored after 5 seconds. The notch filter has no on-screen status icon but *should be left off (0) unless needed.*

## Menu Page-2 [M2]:

[ ] **AGC** (Automatic Gain Control time constant): The time-constant menu is circular: **Slow** > **Fast** > **Automatic** > **Off**. The AGC status icon appears on the display at mid-screen. Icons are **AGC-S** (slow), **AGC-F** (fast), **AGC-A** (Automatic), and **AGC—** (Off). The last setting used is remembered when the radio is turned on. It does not change with the mode unless you have selected **AGC-A** (automatic).

[ ] **FIL** (IF Filter Selection): Three IF filter bandwidths are available -- **0.5 kHz** default for **CW** and **CWR**, **2.4 kHz** default for **USB/LSB**, and **6.0 kHz** default for **AM** (NBFM uses a different IF signal path). The filter menu is circular.

Press **FIL** to deviate from the default setting (FIL changes work in receive mode only). For example, apply 2.4 kHz on **CW** to listen wide, or 6.0 on **SSB** for ESSB. You may also narrow the AM passband using 2.4 kHz. However, during transmissions, the radio always reverts to the transmit default. The filter status indicator appears on the right-hand side of the display (example: **FIL-2.4k**).

[ ] **SRM** (Scan Receive Mode): Press **SRM** and AF output shuts off while the receiver sweeps from below to above the operating frequency, graphically displaying band activity. Set **Sweep Width** by toggling the **BW** soft key (wide, medium, narrow). The receiver continues scanning until you press **MON** to resume listening on the center frequency, or press **QUIT** to terminate the scan function and resume normal operation.

[ ] **SWR** (Plot Antenna SWR). Disengage the **ATU** before making SWR readings. Connect the antenna or load under test to the antenna jack and tune the **VFO** to the desired center frequency. Press **SWR** to start the scan. The radio will switch to transmit mode and a graphic **SWR** display will appear on screen. The default scan width is **100 kHz** in **1-kHz** steps ( $\pm 50$  kHz of center). **1 kHz** appears on screen to indicate the step spacing. The center frequency is also displayed. One complete scan requires about 15 seconds.

Five **Scan Width** settings are available (from 100 kHz to 500 kHz). Each scan has 100 sampling points, so the interval between samples automatically increases with the scan width (from 1 kHz to 5 kHz). To widen the scan, press **BW** (bandwidth) and toggle through the five choices. With each new choice, the scan resets and begins over. The radio will continue scanning until you press **QUIT**. **Quit** returns the radio to receive mode. Note that SWR measurements may be limited to in-band frequencies -- the X5105 does not generate transmit signals outside US ham bands.

***Important Warning:** When scanning SWR, always confirm that a workable antenna or reasonable load is connected to the antenna jack.*

## Menu Page-3 [M3]

[ ] **M>V** (Recall Memory Channel to the VFO): This function recalls operating channels previously stored in memory (the X5105 has 100 channels available). To access the memory bank, press **M>V**. A memory channel icon will flash at the top of the display (**CH-00**). Scroll the **VFO** encoder clockwise to select the channel number you wish to recall (example: **CH-03**), then press the **YES** soft-key to complete the transfer. To escape an operation without completing it, select **NO**. The radio will return to normal operation. If there are no saved channels in memory, a **Memory Empty** icon will appear on the soft-key line at the bottom of the screen.

[ ] **MW** (Write VFO to a Memory Channel): To write a current operating setup into memory, press **MW**. The channel status indicator will flash at the top of the display showing **CH-00**. Rotate the encoder clockwise until a number appears with a **E** in front of it (**E** indicates the selected channel is empty). To load that channel,

press the **YES** soft key (or press **NO** to escape). The radio will store the entry and return to normal VFO operation. Should you accidentally try to overwrite an occupied memory slot, the operation will abort and switch the radio back to VFO operation. To write a new setup into a currently occupied memory channel, *you must first clear out the existing data*. See **MC** (Memory Clear) below.

[ ] **MC** (Memory Clear): Press **MC** to bring up the Channel Select function on the display (**CH-00**). Next, rotate the channel encoder to find the memory slot you wish to clear. Press **YES** to clear it, or **NO** to escape. When completed, normal VFO operation will be restored.

[ ] **Read a TAG**: The **TAG** function labels memory channels for more convenient identification. To read an existing TAG, go to MEMORY mode using **M/V** button (upper right-hand corner). Next, use **VFO** to scroll to an occupied channel (**CH-XX**) that has been tagged. To read the TAG, select **MENU** page **3**, then press the **TAG** soft key. The soft-key will change to **>TAG** and the TAG will replace the frequency in the screen display. Press **TAG** again to exit back to the operating frequency.

[ ] **Write a TAG**: Each **TAG** may be up to 9 characters long. To write a TAG, first select the channel you wish to label and then go to **MENU** page **3**. Next, *press and hold TAG* for 2-3 seconds. When you release it, the radio's text editor will come up on screen. Locate the blinking cursor in the upper-left corner and rotate the **VFO** encoder to find your first character. When it appears, press **ADD** to lock it in. The cursor then automatically shifts to the next character. To add a space between words, insert the thin space marker ( **\_** ). The space marker is next to the **^** symbol in the character list. To make corrections or deletions, shift the cursor using the **<** and **>** keys. Press **DEL** to delete characters. Once the message is complete, press **SAVE** to load it into the memory. Press **TAG** again to exit.

#### **Menu Page-4 [M4]**

[ ] **BK** (break-in): The soft key toggles between **BK ON** and **BK OFF**. **BK ON** engages the transmitter to send CW over the air. **BK OFF** allows you to practice sending or check CW memories without transmitting.

[ ] **KEY**: **Manual** = Straight Key (or external keyer), **Auto-L** = dash left-paddle, **Auto-R** = dash right-paddle.

[ ] **KSP**: (Keyer Speed). Press **KSP** to display current speed in WPM on screen. Rotate **VFO** to change speed setting. Press **KSP** again to lock in new speed and return to VFO operation.

**Practice Mode**: To practice sending CW, first switch to **BK OFF** to disable the transmitter. Set **KEY** for the type of key or paddle you are using -- and adjust sending speed using **KSP**. Finally, go to the System Menu to adjust side-tone pitch (entry 03) and beep volume (entry 15) to your preference.

#### **Menu Page-5 [M5]**

[ ] **RE1-RE3 Playback**: To call up an existing CW-memory file, Press **RE1**, **RE2**, or **RE3**.

[ ] **RE1-RE3 Record**: Press and Hold the desired channel key for 2-3 seconds. The screen and soft-key labels will switch over to **Text-Editor** mode. Each memory channel holds up to 100 CW characters.

To begin entering your message, locate the blinking cursor in the upper-left corner of the screen. Next, rotate the **VFO** encoder to bring up your first character (turn clockwise for capital letters, counter-clockwise to find numbers). When the desired character appears, press **ADD** to lock it in. The cursor then automatically shifts to the next character – use **VFO** to change it. To add a space between words or numbers, insert a thin space marker **\_**. The space marker follows the **^** in the character list. To make corrections, shift the cursor left or right using the **<** or **>** keys. Press **DEL** to delete characters. Once the message is complete, press **SAVE** to

load it into the memory.

[ ] **CSN**: Use this file to personalize the boot screen that appears when the radio is turned on. It holds up to 13 characters for your name, call letters, etc. Press **CSN** to bring up the Text Editor and use the same procedure outlined for the **RE** files to load your information.

#### **Menu Page-6 [M6]**

[ ] **SQL** (Squelch): Press **SQL** and **SQL LEVEL** appears on the right side of the screen with a number between **0-10** directly below. **0** signals the Squelch is turned off. To turn it on, rotate **VFO** until the receiver noise quiets. Press **SQL** again to resume normal operation. The squelch is normally reserved for FM, but works on all modes. Be sure to set it to **0** when not in use.

[ ] **CMP** (Compressor): Press **CMP** to activate processing. When **on**, the **>** symbol appears next to the **CMP** soft-key. Also, a **COMP** icon appears on the screen. Press **CMP** again to turn the processor off.

[ ] **MTR** (Meter): Toggles the bar-graph meter scale under the S-meter scale between **PWR Meter** (percentage of transmit power) and **SWR Meter** (SWR Ratio).

[ ] **VLT** (Voltage): Press **VLT** to toggle between battery-charge percentage icon (  ) and supply voltage reading at the upper right-hand corner of the screen.

#### **Menu Page-7 [M7]**

[ ] **CHG** (Charge): Press **CHG** to toggle the battery charging function on or off. We recommend leaving it off if you plan to transmit.

[ ] **MSL** (Microphone Selector): Press to scroll through the three AF-input options: **INT MIC** = Front-Panel Microphone, **EXT MIC** = Handheld Microphone, **AUX LINE IN** = Auxiliary Jack. This line is used by a data modem or other external AF source. **EXT MIC** is the default.

[ ] **IFO** (IF Output Line): Toggle to enable or disable the **IF Output** line (used with broadband displays). **IF-Out Disable** is the default setting.

[ ] **VER** (Version): Press **VER** to see the radio's current firmware version.

#### **Menu Page-8 [M8]**

[ ] **MDN** (Data Modem): This function allows you to copy PSK-31 signals on the display screen without using an external modem or computer. Place radio in SSB mode, then press **MDN** to access the modem display screen. The graphic display shows PSK signals present in the receiver's passband. Tune the **VFO** to move the spectrum display up or down in frequency relative to the triangular decoding marker underneath. When a PSK signal is centered on the triangular marker, the modem will lock onto it and begin streaming text below the spectrum display. Three lines of on-screen copy shown. Tuning is very critical, so we recommend using the AFC correction option to compensate for drift. PSK-31 signals are normally clustered around 3.580.150 MHz, 7.035.150 MHz, and 14.070.150 MHz.

[ ] **CAR** (Carrier): Phase method of frequency correction – alternative to AFC.

[ ] **AFC** (Automatic Frequency Control): Turn on **AFC** while monitoring PSK signals to ensure the decoder remains locked in to the incoming signal.

#### **Menu Page-9 [M9]**

[ ] **AFF** (Audio Frequency Filter): Press **AFF** to toggle digital AF-filtering **ON** or **OFF**. When filter is engaged, the > **AFF** soft-key marker appears along with **HPF** (High-Pass Filter) and **LPF** (Low-Pass Filter) markers.

[ ] **HPF**: Press to set low-frequency cutoff. **AF HPF** and cut-off frequency appear on screen. Adjustment range is 100 to 1000 Hz. Rotate **VFO** to set the cut-off, press **AF HPF** again to exit.

[ ] **LPF**: Press to set the high-frequency cut-off. **AF LPF** and cut-off frequency appear on screen. Adjustment range is 500 Hz to 3600 Hz. Rotate **VFO** to set the cut-off, press **AF LPF** again to exit.

[ ] **SPK** (Speaker): Press **SPK** to attenuate audio output for safe and comfortable listening levels when using headphones. The >**SPK** soft-key label appears, and a headphone icon appears on the left side of the screen. Press again to return to Speaker Mode (a loudspeaker icon will replace the headphone icon).

## System Menu

Each X5105 is adjusted individually at the factory to ensure optimum performance, but you may access the **System Menu** and fine-tune some of the parameters to preference. To enter **System Menu**, press and hold **MENU** for 1-2 seconds. When you release, the screen will come up on the menu item last viewed. Look for the *number and item* information at the top-left of the display. The *set-value* for each item will be prominently displayed at mid-screen. Rotate the **VFO** encoder to alter *set-value*. Use the soft keys to navigate through the System Menu and to enter set-value changes. Commands are listed below:

[ ] < : Step back to the previous Menu item

[ ] **NO**: Do not enter a newly selected value (escape)

[ ] **YES**: Overwrite the previous set-value with the new value

[ ] > : Step forward to next menu item.

#	Menu Item	Description	Range	Default
01	RF gain	Receiver RF Gain	0-100%	65%
02	CW T/Rx Delay Time	CW TX Delay	0-5000 mS	200 mS
03	CW Rx Side Tone	CW Side Tone Pitch	50-1200 Hz	800 Hz
04	Tx AF Gain SSB	SSB Mic Gain Setting	0-100%	80%
05	Tx AF Gain AM	AM Mic Gain Setting	0-100%	60%
06	Tx AF Gain NFN	NBFM Mic Gain Setting	0-100%	100%
07	Rx AF Gain SSB	SSB Receiver AF Gain	10-100%	40%
08	RX AF Gain AM	AM Receiver AF Gain	10-100%	40%
09	Rx AF Gain NFM	NBFM Receiver AF Gain	10-100%	40%
10	LCD Backlight Level	Screen Brightness	0-100%	80%
11	Ref Clock	System Clock Reference	Do Not Adjust!	26000000 Hz
12	NFM Tx IF	NBFM TX Frequency Adj.	----	10697000 Hz
13	Misc Option	0x59A03360	Do Not Reset!	----
14	Beep Volum	Beep Volume Control	----	15
15	Aux AFIN Volum	ACC Port Input Volume	----	7
16	Aux AFOUT Volum	ACC Port Output Volume	----	63
17	User Key F1	F1 Button Customize	----	TS-
18	User Key F2	F2 Button Customize	----	TS+
19	Ext MIC Bias	External Mic Bias Setting	Disable/Enable	Enable



<b>20</b>	CTCSS Tone	CTCSS Tone Frequency	----	88.5 Hz
<b>21</b>	CTCSS (Tx only)	Tone –Transmit only	----	Disable
<b>22</b>	Reset ALL	Reset - Factory Parameters	No/Yes	No*

\*Use *Reset All* only if a software glitch renders the radio unusable or to activate new firmware.

Don't make any adjustments in the System Menu unless you feel technically competent to do so and understand what the impact will be on normal operation. If you make gain changes, write down the original setting first, then introduce new values in small increments. If you find that the FM carrier frequency is off frequency use an accurate frequency counter and adjust **12** NFM Tx IF setting up or down by the amount of the error.

## 60M OPERATION

When operating on the 60 Meter band you have to dial in the correct channel frequencies. It is recommended that the channels be programmed into memory for convenient retrieval.

<u>USB</u>	<u>CW DATA</u>
5330.5	5332.0 MHz
5346.5	5348.0 MHz
5357.0	5358.5 MHz
5371.5	5373.0 MHz
5403.5	5405.0 MHz

## REMOTE BAND TRACKING

The X5105 Accessory Port (ACC) provides dc voltage levels to drive remotely controlled band-switching circuitry in RF amplifiers and other devices. The band-tracking voltage appears on the *Band* pin of the connector (see ACC connector diagram on page-3).

<u>Band</u>	<u>Voltage</u>	<u>Band</u>	<u>Voltage</u>
160-M	230 mV	17-M	1610 mV
80-M	460 mV	15-M	1840 mV
60-M	690 mV	12-M	2070 mV
40-M	920 mV	10-M	2300 mV
30-M	1150 mV	6-M	2530 mV
20-M	1380 mV	-----	-----

## DATA COMMUNICATION

You may transmit as well as receive data using PSK-31 and other digital modes by connecting your computer through a USB Radio Interface such as the MFJ-1204. Refer to the radio's ACC jack diagram for pin connections. Be sure to follow all instructions and operating suggestions in your USB interface manual and operating software.

## FIRMWARE UPDATES

[ ] To update your firmware, *do not go to the cqxiegu website*. Instead use the latest firmware download available at <https://www.mfjenterprises.com/SoftwareDownloads.php>.

[ ] You'll also need to download the *TeraTerm* freeware terminal emulator program to establish Com-Port

communication between your pc and the radio. Go to <http://tssh2.osdn.jp/> with a download the link in the middle of the page.

Note that there are two sets of X5105 download instructions – one for firmware version *V1\_0\_03 and older* – and one for *V1\_0\_04 and newer*. Check your current firmware version using **Menu 7, VER**. Both procedures are outlined below.

## UPDATING FIRMWARE FOR V1\_0\_03 AND OLDER

### Terminal Program Setup using TeraTerm:

Plug the radio's programming cable into an open USB slot on your computer.

Note that there are two versions of the X5105 programming cable. The first version is a *Prolific* clone that requires an older driver. This driver can be downloaded from the MFJ website. The newer version uses an internal *FTDI* chip. Windows should locate it and download the driver automatically. If not, find it at <http://www.ftdichip.com/Drivers/VCP.htm> Once installed, *TeraTerm* should list the assigned COM port unless multiple serial devices are attached to the computer.

Plug the programming cable into the X5105 *COM* jack (or *CI-V* jack on older radios).

Open *TeraTerm* and go to "*SETUP>Serial Port*". Set up as follows:

Port: select the *COM port* assigned to the programming cable

Baud Rate: select *115200*

Data: *8 bit* (default)

Parity: *None* (default)

Stop: *1 bit* (default)

Flow Control: *None* (default)

Click the *OK* button

### Firmware Install:

Unplug power from the X5105. *Press and Hold the VOL UP and VOL DN* buttons as you plug the power cable back in. Release both buttons.

Press the space bar on your computer keyboard. A menu should display on-screen.

Select "*Update Application*".

**IMPORTANT WARNING: Do Not Select "UPDATE BOOTLOADER!"** If the original bootloader is erased, the radio must be sent back to China for a complete firmware reinstall!

Go to *File>Transfer>XMODEM>Send*

Check Option *1K*

Locate the firmware in the box at the top of the open window. Highlight and click *Open*.

A data transfer window will open and indicate the download's progress. Once finished, the window will close and the terminal program will say *Trans finish!* The X5105 will then switch to normal *OFF* mode.

Power up the X5105.

Press and hold the *MENU* button to switch into *System Menu mode*.

[ ] Use the < or > soft-keys to find System Menu entry 22, *Reset All*.

[ ] Turn the VFO knob to display *YES*, then press the Yes soft-key to reset the radio for the new firmware.

### UPGRDING FIRMWARE VERSION V1\_0\_04 AND NEWER

Note -- once you've updated your radio to V1\_0\_04 firmware and newer, the old-version update instructions will no longer apply.

#### Terminal Program Setup Using TeraTerm:

[ ] Plug in the programming cable to the computer.

Note that there are two versions of the X5105 program cable. The first is a *Prolific* clone that requires an old version of the driver. It can be downloaded from the MFJ website. The newer version uses an internal *FTDI* chip. Windows should locate it and download the driver automatically. If not, the driver is available at <http://www.ftdichip.com/Drivers/VCP.htm>

Once installed, *TeraTerm* should list the assigned COM port unless multiple serial devices are attached to the computer.

[ ] Plug the programming cable into the X5105 COM jack (CI-V jack on older radios).

[ ] Open *TeraTerm* and go to *SETUP>Serial Port*.

[ ] Port select the COM port assigned to the programming cable. Set up as follows:

- [ ] Baud Rate: *115200*
- [ ] Data: *8 bit* (default)
- [ ] Parity: *None* (default)
- [ ] Stop: *1 bit* (default)
- [ ] Flow Control: *None* (default)
- [ ] Click the OK button

#### Firmware Install:

[ ] Unplug the power cable from the X5105. Press and hold *VOL UP* and *VOL DN* simultaneously and plug the power cable back in. Release both buttons.

[ ] A message to *cancel the upgrade* will display – giving you a 10-second opportunity to halt the upgrade by pressing either of the two *VOL* buttons (don't press if you wish to continue the download).

[ ] After 10 seconds, the X5105 will automatically erase the old firmware from the radio. *You must install the new firmware at this point*. No display will be shown on the computer.

[ ] Go to *File>Transfer>XMODEM>Send*

[ ] Check Option *1K*

[ ] Locate the firmware in the box at the top of the open window. Highlight and click it open.

A data transfer window will open and indicate the download's progress. Once finished the window will close and the terminal program will display *Trans finish!* The X5105 will then switch to normal *OFF* mode.

[ ] Power the X5105 back up using the *ON* button.

[ ] Press and hold the *MENU* button to switch the radio into *System Menu* mode.

[ ] Use the < or > soft-key buttons to locate **System Menu** Entry 22 - *Reset All*.

[ ] Turn the VFO knob to display *YES*, and then press the *Yes* soft-menu key to reset the radio to the new firmware.

**24-MONTH MFJ WARRANTY:**

If your X5105 was purchased from an authorized MFJ dealer -- or directly from MFJ -- and if you are the original owner, we warrant that it shall be free from defects in material and workmanship for a period of 24 months from date-of-purchase, subject to the following terms and conditions:

1. You must retain a dated proof-of-purchase (bill of sale, cancelled check, credit card or money order receipt, etc.) describing the product to establish the validity of the warranty claim. In addition, the original copy or machine reproduction of such proof shall be provided to MFJ at the time of warranty service. MFJ has discretion to deny warranty service without dated proof-of-purchase. Evidence of alteration, erasure, or forgery shall be cause to void all warranty terms immediately.
2. MFJ agrees to repair or replace, at its option and without charge to the original owner, any defective product covered under this warranty, provided the product is returned postage prepaid to MFJ Enterprises, Inc. with a personal check, cashiers check, or money order in the amount of \$7.00 to cover postage and handling.
3. If the remedy is deemed to be customer serviceable, MFJ Enterprises, Inc. agrees to supply replacement parts free upon request. A dated proof-of-purchase and a \$5.00 personal check, cashiers check, or money order must be provided to cover postage and handling for parts.
4. Under no circumstances shall MFJ Enterprises, Inc. be liable for consequential damages to persons or property through use of this product. In addition, MFJ shall not be liable for repairing or replacing equipment bearing obvious signs of misuse, mishandling, or unauthorized tampering.
5. MFJ Enterprises, Inc. will repair any out-of-warranty product provided the unit is shipped prepaid. All repaired units will be shipped COD to the owner. Repair charges will be added to the COD fee unless other arrangements are made.
6. This warranty is given in lieu of any other warranty expressed or implied.
7. MFJ Enterprises, Inc. and its suppliers reserve the right to make changes or improvements in the design or manufacture of this products without incurring any obligation to install such changes to products previously manufactured.
8. All MFJ products to be serviced in-warranty or out-of-warranty should be addressed to MFJ Enterprises, Inc., 300 Industrial Park Road, Starkville, Mississippi 39759, USA and must be accompanied by a letter describing the problem in detail along with a copy of a dated proof-of-purchase.
9. This Warranty does not cover replacement of batteries subject to deterioration as a function of normal in-service use.
10. This warranty conveys specific rights, and you may also be entitled to other rights which may vary from state to state.